



Wake Up to Warmth



ABOUT VENUS

VENUS HOME APPLIANCES (P) LTD., manufacturers of Venus Water Heaters for 60 years is a market leader and pioneer in the Water Heater industry. Venus is one of the leading brands of water heaters in India and stands for Quality, Reliability and Performance.

Appliances that provide a continual supply of hot water are called water heaters or Electric geysers. Venus Home Appliances is the leading manufacturer of water heaters and geysers in India. Venus has been providing a wide range of water heaters in India that include electric instant water heaters, electric storage water heaters, solar water heaters and heat pump water heaters. Venus Home Appliances strives to design, manufacture, supply water heaters and accessories to national/international standards. Venus has got ISO 9001 certification from BVQI and is ISO14001:2004 and BS OHSAS 18001:2007 certified; a measure of its commitment to quality.



LARGEST EXPORTER

VENUS HOME APPLIANCES (P) LTD., manufacturers of Venus Water Heaters for 60 years is a market leader and pioneer in the Water Heater industry. Venus is one of the leading brands of water heaters in India and stands for Quality, Reliability and Performance. Venus water heaters have sleek exteriors that complement the performance.

With a Presence in more than 22 countries across the World, Venus Home Appliances is the No.1 in Exports with reference to the Water heater Industry.



*Based on customs data



NATIONAL & INTERNATIONAL CERTIFICATION



Winner of the 'National Award for Quality Product' in 2000 by Govt. of India



Twice winner of the 'Tamil Nadu Quality Award'



60 years market leader and a pioneer in the water heater industry



9001 | 14001 | 45001
ISO 9001 & 14001
Certification from BVC



Enameling Process- Hi-Tech Plant

Porcelain Enamel Glass lined tanks are produced in a world-class fully automated plant in Venus using the best raw materials and the highest quality assurance practices.



Stage 1 - **FORMING:**

Deep drawing of 1.8-2mm steel blanks to form lids in a heavy duty Hydraulic Press.



Stage 2 - **WELDING:**

Welding of lids and shells in an automatic, Plasma/MIG Welding Line. All welded tanks are tested immediately at 3 bars pressure; 100% leakage free.

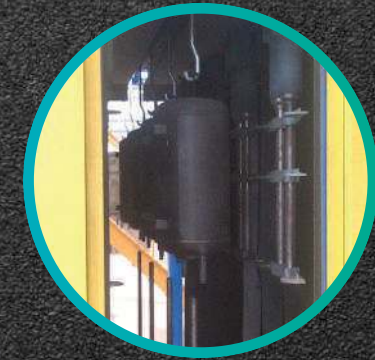

Stage 3 - **PRE-TREATMENT:**

Inner surface of the tank is blasted at high pressure in the shot blasting machine to remove any surface impurities and oxides.

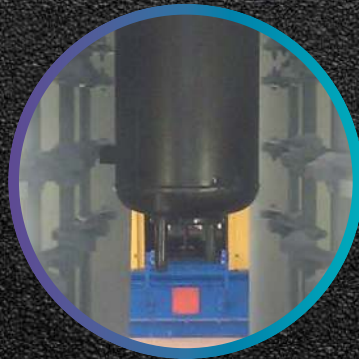

Stage 4 - **ENAMEL APPLICATION:**

Dry Powder Enamel is sprayed on the tanks by 2 robots. Automatic controls maintain a homogeneous coating thickness of 250 μ across the surface of the tank.



Stage 5 - **FIRING:**

Enamel coated tanks are fired inside the high temperature furnace at 830°C – 850°C. The enamel melts to fuse and bond with the steel to form a protective glass lining.

UNIQUE FEATURES

DURABILITY



Porcelain Enamel Glass Lined Tank



30% larger anode for longer Protection



Full face Gasket with Neck Protection



Zn-Ni coated fasteners 5X Rust Resistance



Double side enameling prevents rusting of flange and door plate

PERFORMANCE



Porcelain Enamel Glass Lined Tank: Manufactured in a modern, automated plant using European Technology. Protects the tank from rust and corrosion.



100% pure copper tank: For long life and corrosion free performance.



Glass lined Incoloy 800 element: Withstands temperatures up to 1000°C Long lasting even in hard water reduces scale formation. Prevents premature element failure.



Glasslined Double Ceramic Heating Elements: Shock-proof, hard water proof and long-lasting.



Hard water protection: Low density, Glasslined elements for long life in hard water areas.

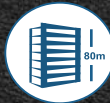

8 bar pressure: Suitable for pressure pumps and multi-storey buildings.



6 bar pressure: High Working pressure that is double that of ordinary Instant water heaters.



Flexi Mount: Flexible mounting options (Horizontal Model) Wall/Floor mounting. Left/right side opening options available - Ideal for modern apartments.

SAFETY



Multi-function valve: Acts as pressure release valve, non-return valve, drain valve, expansion valve and vacuum release valve.



Sacrificial Magnesium Anode: A special device to enhance the corrosion protection of the tank by means of "Cathodic action".



Triple Safety : Multi-function Safety Valve, Capillary Thermostat & Thermal cutout.



IPX4 : Resistant to water splashes from any direction.

ENERGY SAVINGS



5 Star rating for more energy savings.



3cm Thick Polyurethane Foam (PUF) insulation: Reduces heat loss and keeps water hot for much longer.



Power meter: To show actual energy consumption for daily, weekly, monthly, and Annually.

DIGITAL



IoT Empowered : W/H Operation from across the World



Wi-Fi - Enabled : Lets you Set, Schedule & view at your convenience



Smart Modes: Three Energy Saving Smart Shower Modes



Digital Display: For visual indication of temperature.



Multi-function Display: For visual indication of temperature and program options.



Temperature Display : The display will show the real time temperature.

ENDURANCE



10 Years* Guarantee: On Copper tank and Porcelain Enamel glass lined tank (Splash Pro Smart and Splash Pro IoT Models only)



7 Years** Guarantee: On Porcelain Enamel GlassLined Tank



4 Years*** Guarantee: On Heating Element

5-Anti Corrosion Features

Ultimate Durability - Splash pro is designed for durability. With innovative anticorrosion features and hard water protection splash pro is the best among water heaters. Splash pro is built to last for years.



Porcelain Enamel
Glass Lined Tank

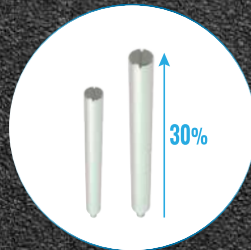

30% larger anode
for longer Protection

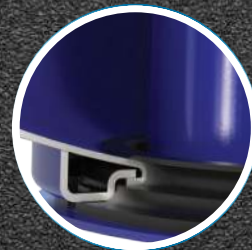

Full face Gasket with
Neck Protection

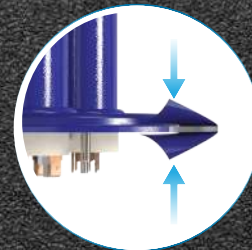

Double side enameling
prevents rusting of
flange and door plate



Zn-Ni coated fasteners
5X Rust Resistance

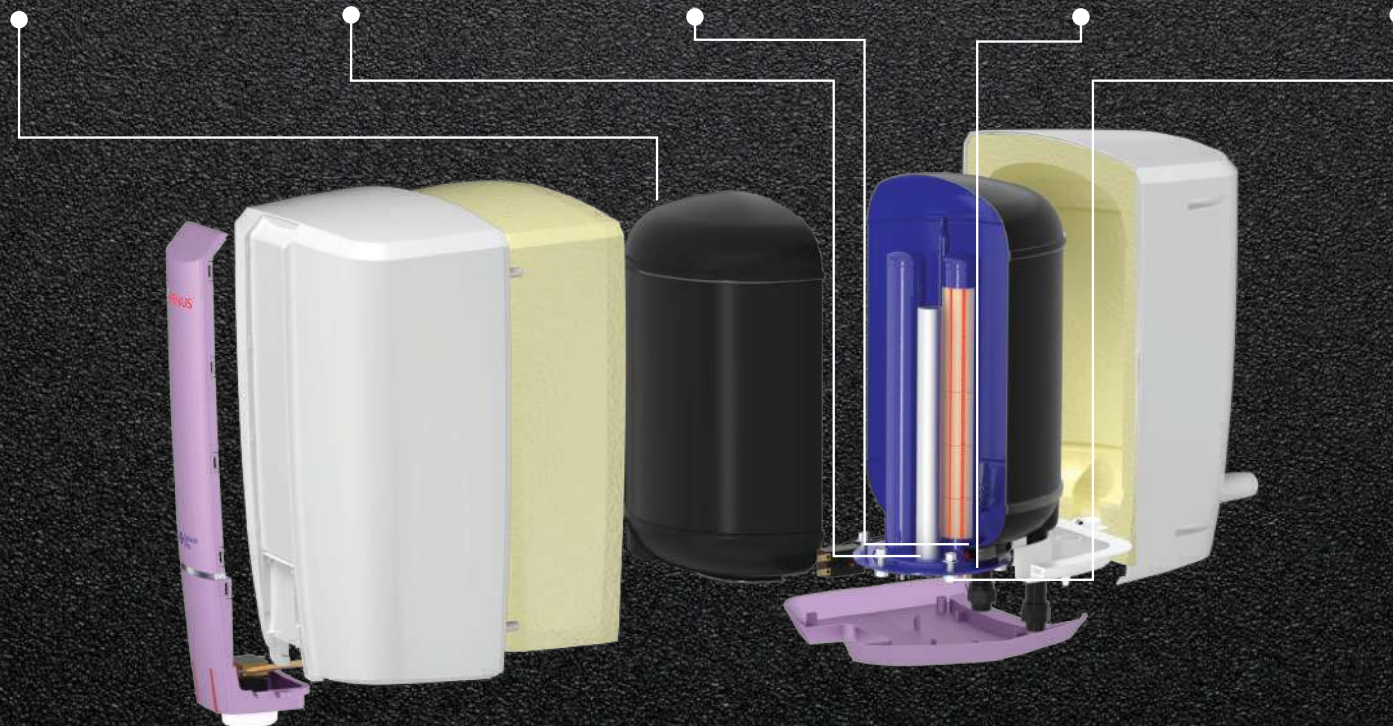

Types of Heating Element

We use different types of heating elements in our water heaters. Which ensures hard water protection and shock protection. They are designed for reliable & energy efficient performance in all types of water conditions. We have higher grade heating elements for hard water areas to resist scale deposits & premature failure. There are 3 types of heating elements : 1. Ceramic Heating element, 2. Glass lined incoloy element, 3. Copper Heating element.



Ceramic Heating Element



Glass lined Incoloy Heating Element

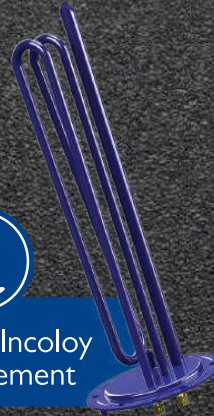

Super Heavy Gauge Copper Element



Scale Guard Technology



In Ceramic heating element, heat is transferred over a much larger surface area, which reduces the stress on heating element, lowers watts density/sq.cm and ensures less scale deposition on the heating element.

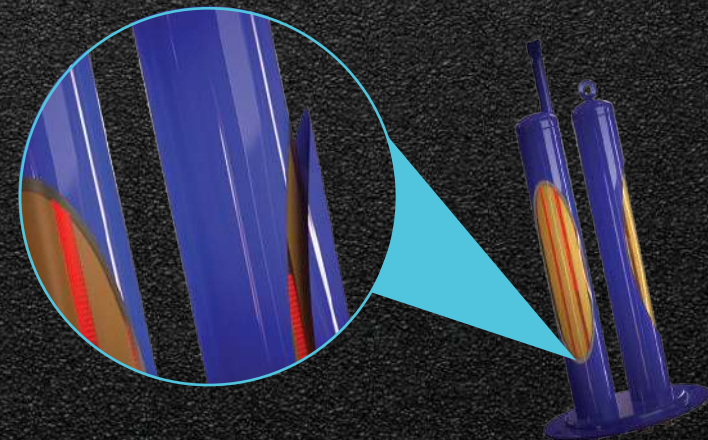

WARMTH FOR LIFE

Venus water heaters are built with state-of-the-art technology and comes equipped with the most innovative features.

- Storage Water Heaters

- Instant Water Heaters

- Tankless Water Heaters

- Solar and Heat Pump Water Heaters



VENUS TECHNOLOGY

Ultimate Performance



Scale Guard Technology



3cm Thick Polyurethane Foam (PUF) Insulation



Colour-Changing Smart LED's

Ultimate Durability and Corrosion Resistance



Porcelain Enamel Glass Lined Tank



Glasslined Double Ceramic Heating Elements with Scale Guard Technology

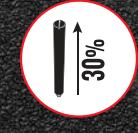

30% larger anode for longer Protection

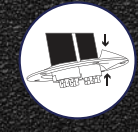

Double side enameling prevents rusting of flange and door plate



Full face Gasket with Neck Protection



Zn-Ni coated fasteners 5X Rust Resistance

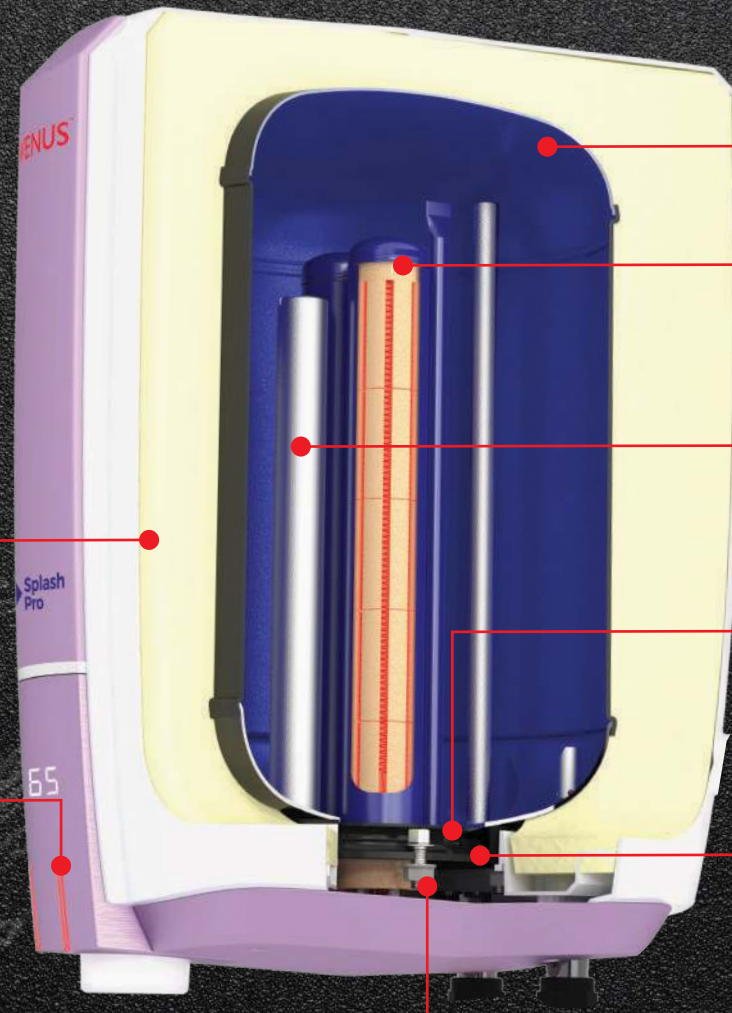

NEW

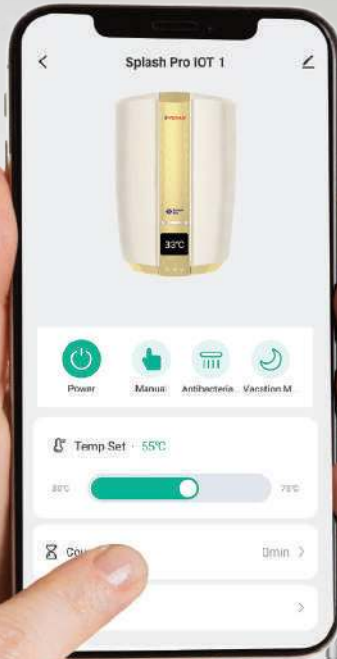

Splash Pro IoT



Graphite Silver

Splash Pro IOT

Embrace the incredible potential of Splash Pro IoT-enabled water heaters to elevate your home's comfort, convenience, and energy efficiency. The smart home revolution has arrived, and with Splash Pro IoT water heater, you can be at the forefront of this exciting transformation. Whether you're seeking convenience, savings, or a greener lifestyle, our Splash IoT water heater your gateway to a future of intelligent, connected living. Embrace the IoT revolution today.



IoT Enabled: Operation the water heater from across the world



Antibacterial Mode: High temperature settings to prevent the growth of harmful bacteria like Legionella

Smart Digital Display



Wi-Fi Enabled: Set , Schedule & View at your convenience

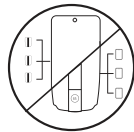

Mobile Application control : One mobile device can control many heaters. Multi -user can control one heater



Smart mode: Energy saving mode with water temperature @ 45° C



App sharing: One Tap to share devices among family members



Timer: A suitable time and day can be set for the Heater to turn on and off.



Vacation Mode: Safety feature for customers while leaving the house.



Hard Water Protection



Anticorrosion Features



Guarantee on inner tank

Model	Wattage	Capacity in Litres	Time to Raise Temp by 35°C	Dimensions (in mm)		
				A	B	C
			Vertical			
15SW	2000	15	20min	488	326	375
25SW	2000	25	33min	545	386	433

Rated Pressure: 8 bars (8kg/cm² ; max, 80m water head)

*Specifications subject to change without prior notice.

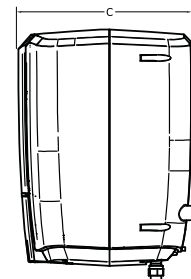
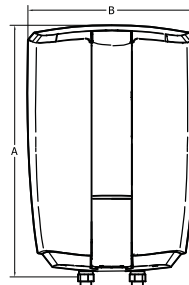

GUARANTEE		
Inner Tank 10 Years	Heating Element 4 Years	Product 2 Years



NEW



Splash Pro Smart



Graphite Silver



Tuscan Gold



Purple Haze

Splash Pro Smart

Introducing "Splash Pro Smart" the smart upgrade of splash pro water heater from venus with elegant central panel design and brushed finish with a collection of delighting colors, Splash pro smart has a convenient digital display to exactly know the temperature of the hot water for a comfortable bath.



Glasslined Double Ceramic Heating Elements with Scale Guard Technology

10 YEARS
Guarantee on Inner Tank

Smart indicator :
Digital Display



Colour Changing Smart LED'S

Blue Heating | Red Ready to use



Anticorrosion Features

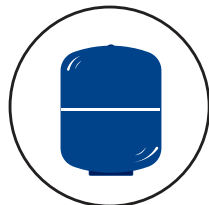

Porcelain Enamel Glass Lined Tank

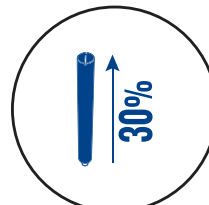

30% larger anode for longer Protection

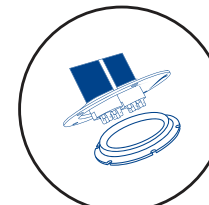

Full face Gasket with Neck Protection

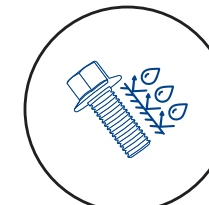

Zn-Ni coated fasteners 5X Rust Resistance

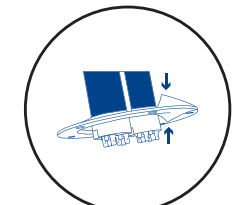

Double side enameling prevents rusting of flange and door plate



Porcelain Enamel Glass Lined Tank



3cm Thick Polyurethane Foam (PUF) Insulation



Scale Guard Technology



Hard Water Protection



Triple Safety: Multi-function Safety Valve along with Capillary Thermostat & Thermal cutout

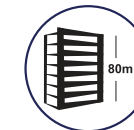

8 bar pressure: Suitable for pressure pumps and multi-storey buildings.

Model	Wattage	Capacity in Litres	Time to Raise Temp by 35°C	Dimensions (in mm)		
				A	B	C
			Vertical			
10SX	2000	10	13min	368	326	375
15SX	2000	15	20min	488	326	375
25SX	2000	25	33min	545	386	433

Rated Pressure: 8 bars (8kg/cm²; max, 80m water head)

*Specifications subject to change without prior notice.

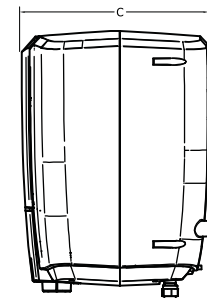
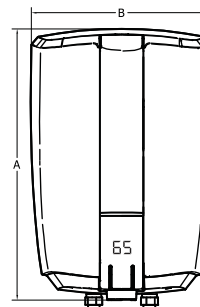

GUARANTEE

Inner Tank 10 Years	Heating Element 4 Years	Product 2 Years
------------------------	----------------------------	--------------------



NEW



Splash Pro



Graphite Silver



Tuscan Gold



Purple Haze

Splash Pro

Introducing "Splash Pro" the smart upgrade of Splash Pro water heater from Venus with elegant central panel design and brushed finish with a collection of delighting colors.



Glasslined Double Ceramic Heating Elements with Scale Guard Technology

Colour Changing Smart LED'S

Blue Heating

Red Ready to use



Anticorrosion Features

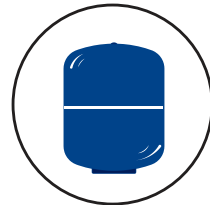

Porcelain Enamel Glass Lined Tank

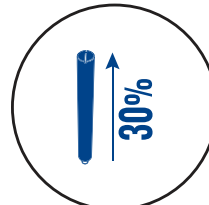

30% larger anode for longer Protection

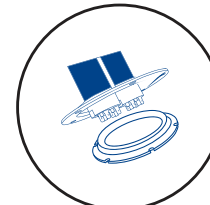

Full face Gasket with Neck Protection

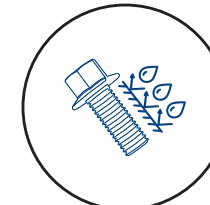

Zn-Ni coated fasteners 5X Rust Resistance

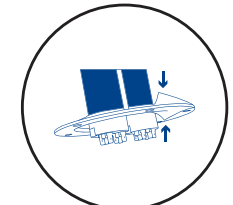

Double side enameling prevents rusting of flange and door plate



Porcelain Enamel Glass Lined Tank

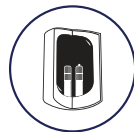

3cm Thick Polyurethane Foam (PUF) Insulation



Copper Heating Element (6SB models Only)



Hard Water Protection



Triple Safety: Multi-function Safety Valve along with Capillary Thermostat & Thermal cutout

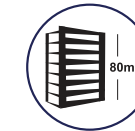

8 bar pressure: Suitable for pressure pumps and multi-storey buildings.

Model	Wattage	Capacity in Litres	Time to Raise Temp by 35°C	Dimensions (in mm)		
				A	B	C
06SB	3000	06	06min	298	336	340
10SB	2000	10	13min	368	326	375

Rated Pressure: 8 bars (8kg/cm² ; max, 80m water head)

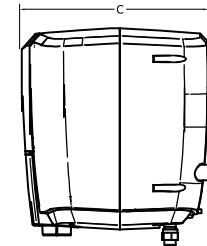
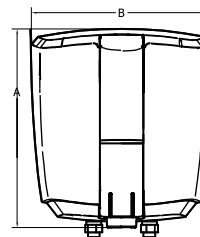

*Specifications subject to change without prior notice.
*6 Ltr Image is different look, *Copper Heating Element in 6SB Model.

GUARANTEE

Inner Tank 7 Years	Heating Element 4 Years	Product 2 Years
-----------------------	----------------------------	--------------------

* 2 Years Guarantee on Copper Heating Element.



Splash Copper



Copper

Splash Copper

Splash copper is built to last. Made with sturdy & 100% copper parts - copper tank and heavy gauge copper heating element which guarantees corrosion proof performance for ages. A completely reliable water heater, Splash Copper provides you years of trouble free performance.



Copper Tank + Element



100% pure copper tank: For long life and corrosion free performance. Heavy Gauge, Ribbed for extra strength.

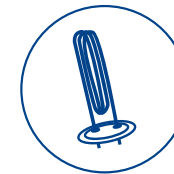

Super Heavy Gauge Copper Element



Hard Water Protection



Thick Polyurethane Foam (PUF) Insulation

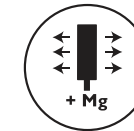

Sacrificial Magnesium Anode for Corrosion protection



10 Years guarantee : on Copper tank



Triple Safety: Multi-function Safety Valve along with Capillary Thermostat & Thermal cutout



Guarantee on inner tank

Model	Wattage	Capacity in Litres	Time to Raise Temp by 35°C	Dimensions (in mm)		
				A	B	C
			Vertical			
10CU	2000	10	13min	350	316	316
15CU	2000	15	20min	475	316	325
25CU	2000	25	33min	520	366	380

Rated Pressure: 6 bars (6kg/cm² ; max, 60m water head)

*Specifications subject to change without prior notice.

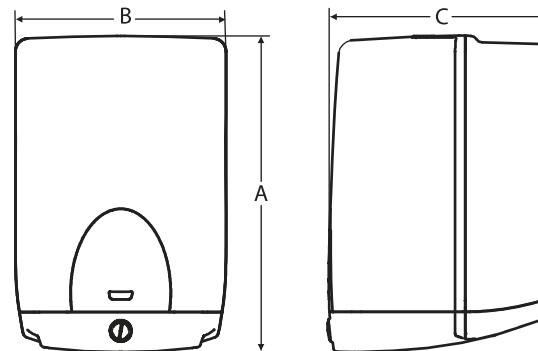

GUARANTEE

Inner Tank 10 Years	Heating Element 4 Years	Product 2 Years
------------------------	----------------------------	--------------------



NEW

Vectra



Silver Sparkle

Vectra

Introducing VECTRA, a matchless beauty with one of its kind square design and convenient INSTA COLOR PANELS (Sunset Gold and Designer Black) that matches the elegance of your bathroom interiors. Optimum performance with Porcelain Enamel Glasslined tank, this beauty gives long life and lower energy consumption. This unique model comes with a 3.5cm PUF insulation ensuring better heat retention



Compact Form: Square design - The Unique square design adds a class of elegance for the bathroom interiors

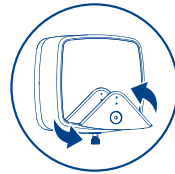

Insta Color Panels (Swap) : Insta color panels with attractive two colors (Sunset Gold and Designer Black) which is given free inside the box adding charm to your bathroom interiors



Porcelain Enamel Glass Lined Tank



Glasslined Incoloy Element

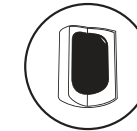

3.5cm Thick Polyurethane Foam (PUF) Insulation

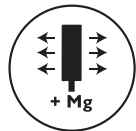

Sacrificial Magnesium Anode for Corrosion protection



Triple Safety: Multi-function Safety Valve along with Capillary Thermostat & Disc Thermal cutout



8 bar pressure: Suitable for pressure pumps and multi-storey buildings.

Model	Wattage	Capacity in Litres	Time to Raise Temp by 35°C	Dimensions (in mm)		
				A	B	C
			Vertical			
10VS	2000	10	13min	374	374	288
15VS	2000	15	20min	410	410	315
25VS	2000	25	33min	460	460	372

Rated Pressure: 8 bars (8kg/cm² ; max, 80m water head)

*Specifications subject to change without prior notice.

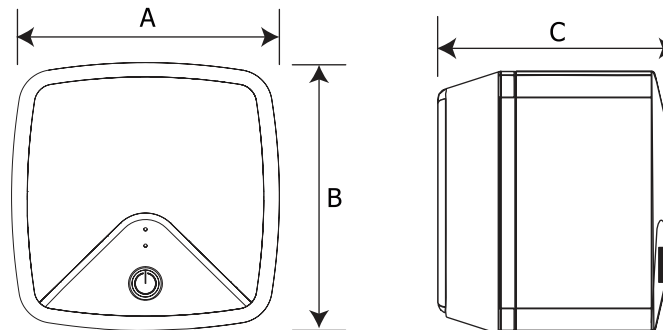

GUARANTEE		
Inner Tank 7 Years	Heating Element 2 Years	Product 2 Years



Lyra



Red



Orange



Royal Blue



Purple

Lyra

Introducing the all new Lyra - the ultimate water heater for the new generation. A sleek new design that will suit your modern bathroom interiors and smart indicator with color changing LED rings (Blue for heating and Red for ready to use) gives you the ease and Convenience !!!

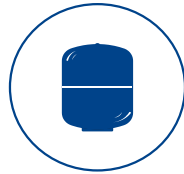

• **Porcelain Enamel Glass Lined Tank:** Manufactured in a modern, automated plant using European Technology. Protects the tank from rust and corrosion.

Smart Indicator Colour Changing LED ring



Heating



Ready to Use



Glass lined Incoloy element



Thick Polyurethane Foam (PUF) Insulation

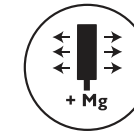

Sacrificial Magnesium Anode for Corrosion protection



Hard Water Protection



Triple Safety: Multi-function Safety Valve along with Capillary Thermostat & Thermal cutout

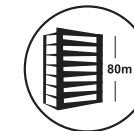

8 bar pressure: Suitable for pressure pumps and multi-storey buildings.

Model	Wattage	Capacity in Litres	Time to Raise Temp by 35°C	Dimensions (in mm)		
				A	B	C
			Vertical			
10R	2000	10	13min	367	325	325
15R	2000	15	20min	470	325	325
25R	2000	25	33min	530	377	374

Rated Pressure: 8 bars (8kg/cm² ; max, 80m water head)

*Specifications subject to change without prior notice.

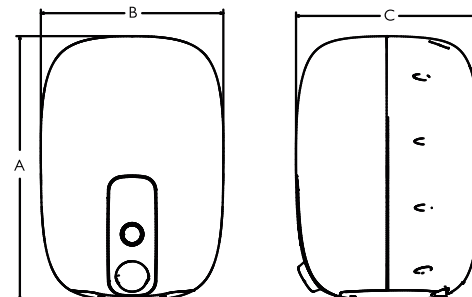

GUARANTEE

Inner Tank 7 Years	Heating Element 3 Years	Product 2 Years
-----------------------	----------------------------	--------------------



NEW



Sedra



Rustic Gold



Silver Slate

Sedra

Introducing Sedra Storage water heaters, built to withstand the test of time and provide you with reliable warmth and comfort. From the robust outer shell to the internal components, every aspect of our water heaters is engineered for longevity. Sedra water heaters are built tough for the long haul and have been constructed to resist corrosion.



Glasslined Double Ceramic Heating Elements
Shock-proof, hard water proof, long-lasting (All vertical & except 6SV model).



Colour Changing Smart LED's

Heating **Ready to use**



Porcelain Enamel Glass Lined Tank

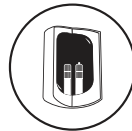

3.5cm Thick Polyurethane Foam (PUF) Insulation

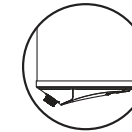

Elegant Design



Temperature Display : The display will show the real time temperature.



Plastic Outer Body : Corrosion free. Shock proof.



Scale Guard Technology

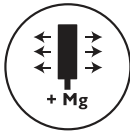

Sacrificial Magnesium Anode for Corrosion protection



Triple Safety: Multi-function Safety Valve along with Capillary Thermostat & Thermal cutout

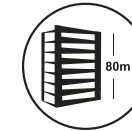

8 bar pressure: Suitable for pressure pumps and multi-storey buildings.

Product Specifications*

MODEL	WATTAGE	CAPACITY IN LITRES	TIME TO RAISE TEMP BY 35°C	DIMENSIONS (in mm)			
				A	B	C	D
VERTICAL							
06SV	3000	6	6min	308	337	-	201
10SV	2000	10	13min	381	337	-	201
15SV	2000	15	20min	496	337	-	201

Rated Pressure: 8 bars(kg/cm² ; max, 80m water head)

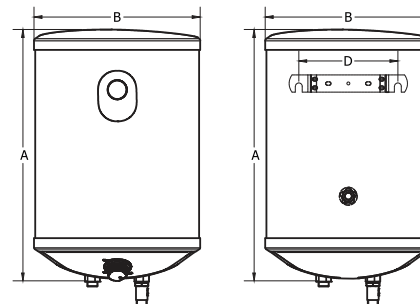

*Specifications subject to change without prior notice.

*Copper Heating Element in 6SB Model.

GUARANTEE

Inner Tank 7 Years	Heating Element 3 Years	Product 2 Years
-----------------------	----------------------------	--------------------

* 2 Years Guarantee on Copper Heating Element.



Magma Plus



Honey Gold



Sliver Sparkle

Magma Plus

Magma plus have been built to last and designed to be hard water proof with scale guard technology. An updated and pleasing design with colors in metallic finish lends this model a new grace and charm to blend with your bathroom decor.



Porcelain Enamel Glass Lined Tank: Manufactured in a modern, automated plant using European Technology. Protects the tank from rust and corrosion.



Glasslined Double Ceramic Heating Elements with Scale Guard Technology



Glasslined Incoloy Element (Horizontal Models only)



3cm Thick Polyurethane Foam (PUF) Insulation

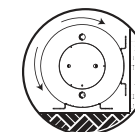

Flexi Mount (Only for Horizontal)



Temperature Display : The display will show the real time temperature.



Shock-proof Design : PP Plastic in Lids and outer body



Scale Guard Technology



Hard Water Protection



Triple Safety: Multi-function Safety Valve along with Capillary Thermostat & Thermal cutout

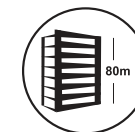

8 bar pressure: Suitable for pressure pumps and multi-storey buildings.

Model	Wattage	Capacity In Litres	Time To Raise Temp By 35°C	Dimensions (in mm)			
				A	B	C	D
VERTICAL							
025GV	2000	25	33min	545	363	-	201
035GV	2000	35	45min	680	363	-	201
050GV	2000	50	64min	590	453	200	201
070GV	3000	70	60min	765	453	367	201
100GV	3000	100	85min	1005	453	609	201
150GV	3000	150	122min	1455	453	1009	201
Horizontal							
010GH	2000	10	13min	390	313	145	201
015GH	2000	15	20min	505	313	160	201
025GH	2000	25	33min	665	313	317	201
035GH	2000	35	45min	680	363	277	201
050GH	2000	50	64min	890	363	474	201
070GH	3000	70	60min	765	453	367	201
100GH	3000	100	85min	1005	453	609	201
150GH	3000	150	122min	1455	453	1009	201

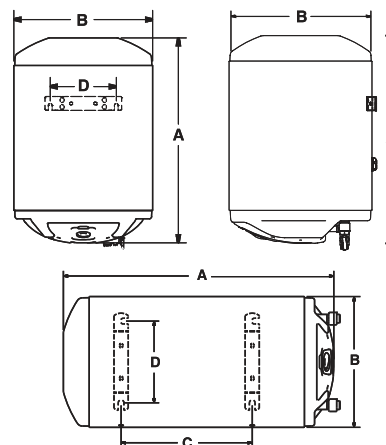

*Specifications subject to change without prior notice.
*Copper Heating Element in 10GH models.

GUARANTEE

Inner Tank 5 Years	Heating Element 2 Years	Product 2 Years
-----------------------	----------------------------	--------------------



Celo Smart



White

Celo Smart

The Stylish designed water heater with a combination of safety, efficiency and technology ensures energy efficient performance. The versatile water heater with the smart Indicator digital display & color changing LED rings makes you ready to enjoy a hot shower !!!



Porcelain Enamel Glass Lined Tank: Manufactured in a modern, automated plant using European Technology. Protects the tank from rust and corrosion.



Heat Retention Technology : No Thermal Bridge between the Tank and the external Housing, thereby enabling 16% lower Thermal Losses.



Digital Display : For visual indication of temperature.



Glasslined Incoloy Element



3cm Thick Polyurethane Foam (PUF) Insulation



Temperature Display : The display will show the real time temperature.

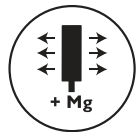

Sacrificial Magnesium Anode for Corrosion protection



Triple Safety: Multi-function Safety Valve along with Capillary Thermostat & Thermal cutout



8 bar pressure: Suitable for pressure pumps and multi-storey buildings.



Blue for Heating



Red for Ready to use

Model	Wattage	Capacity in Litres	Time to Raise Temp by 35°C	Dimensions (in mm)			
				A	B	C	D
			Vertical				
010CVD	2000	10	13min	385	321	-	201
015CVD	2000	15	20min	475	321	-	201
025CVD	2000	25	33min	530	371	-	201
050CVD	2000	50	64min	875	371	474	201

Rated Pressure: 8 bars (8kg/cm² ; max, 80m water head)

*Specifications subject to change without prior notice.

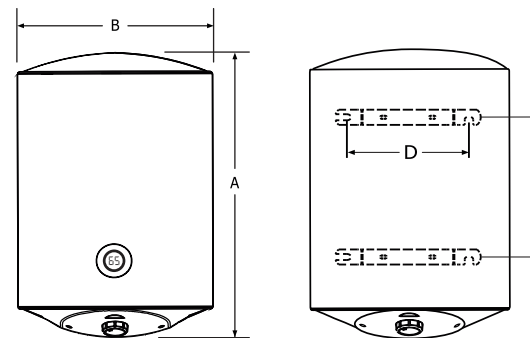

GUARANTEE		
Inner Tank 7 Years	Heating Element 2 Years	Product 2 Years



Celo



Ivory



White

Celo

Celo the most versatile water heaters is energy efficient in performance with a stylish design. Safety, efficiency and technology combined in one water heater.



Porcelain Enamel Glass Lined Tank: Manufactured in a modern, automated plant using European Technology. Protects the tank from rust and corrosion.



Heat Retention Technology : No Thermal Bridge between the Tank and the external Housing, thereby enabling 16% lower Thermal Losses.



Glasslined Incoloy Element



3cm Thick Polyurethane Foam (PUF) Insulation



Temperature Display : The display will show the real time temperature.

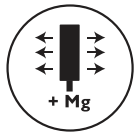

Sacrificial Magnesium Anode for Corrosion protection



Triple Safety: Multi-function Safety Valve along with Capillary Thermostat & Thermal cutout



8 bar pressure: Suitable for pressure pumps and multi-storey buildings.

Model	Wattage	Capacity in Litres	Time to Raise Temp by 35°C	Dimensions (in mm)			
				A	B	C	D
Vertical							
006CV	3000	6	6min	295	321	-	201
010CV	2000	10	13min	385	321	-	201
015CV	2000	15	20min	475	321	-	201
025CV	2000	25	33min	530	371	-	201
035CV	2000	35	45min	667	371	-	201
050CV	2000	50	64min	875	371	474	201
Horizontal							
015CH	2000	15	20min	475	321	160	201
025CH	2000	25	33min	655	321	317	201
050CH	2000	50	64min	875	371	474	201

Rated Pressure: 8 bars (8kg/cm² ; max, 80m water head)

*Specifications subject to change without prior notice.

**Copper Heating Element 2 Years Guarantee for 6CV model.

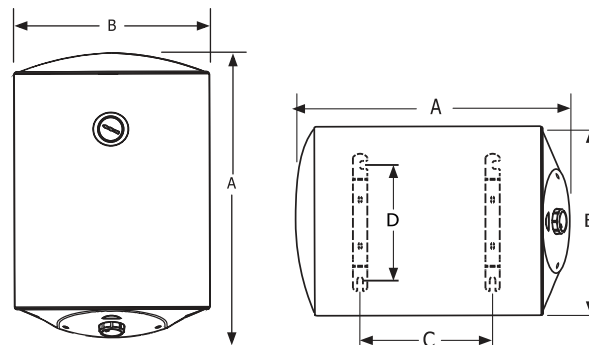

GUARANTEE

Inner Tank 7 Years	Heating Element 2 Years	Product 2 Years
-----------------------	----------------------------	--------------------



Slim Series



White

Slim Series

Introducing Slim series water heater. With only 12" Diameter it is ideal for fixing above false ceilings and in bathrooms with low ceilings.

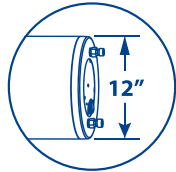

Slim design with 12" diameter: It can be easily concealed inside a false ceiling or fixed in the smallest space.



Rustproof ABS Lids: With Aesthetic Design and Stylish bottom inspection cover.



Porcelain Enamel Glass Lined Tank

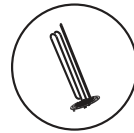

Glasslined Incoloy Element



Thick Polyurethane Foam (PUF) Insulation

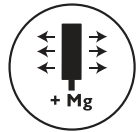

Sacrificial Magnesium Anode for Corrosion protection



Triple Safety: Multi-function Safety Valve along with Capillary Thermostat & Thermal cutout



8 bar pressure: Suitable for pressure pumps and multi-storey buildings.

Model	Wattage	Capacity in Litres	Time to Raise Temp by 35°C	Dimensions (in mm)			
				A	B	C	D
			Vertical				
010HS	2000	10	18min	355	305	145	201
015HS	2000	15	20min	475	305	192	201
025HS	2000	25	33min	645	305	365	201

Rated Pressure: 8 bars (8kg/cm²; max, 80m water head)

*Specifications subject to change without prior notice.

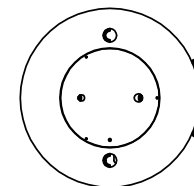
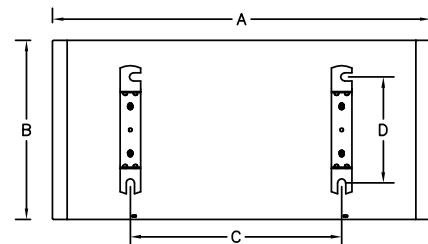

GUARANTEE

Inner Tank 5 Years	Heating Element 2 Years	Product 2 Years
-----------------------	----------------------------	--------------------



Quik Tankless



Q123 / Q153 / Q183 / Q243



Q55 / Q68



Q90



QU55



QU75

Quik Tankless

Get hot water in no time with QUIK Tankless water heaters designed with a unique heat exchanger technology for an instant relaxing shower every day this water heater also has an advanced microprocessor control for constant temperature output.

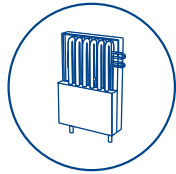

Tankless Heat Exchanger Technology: The heating element and water pipe are molded together for quick transfer of heat from element to the water without contact. This ensures quick heating, long life and safety.



Digital Temperature Display: The set and actual temperature are prominently displayed.



Flow Based Operation



Over heat Protection



Constant temperature output



Earth Leakage Protection

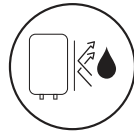

ABS Outer Body : Corrosion free. Shock proof.



6 bar pressure: Suitable for pressure pumps and multi-storey buildings.

Quik	Q55	Q68	Q90	Q123	Q153	Q183	Q243	QU55	QU75
Wattage	5500 W	6800 W	9000 W	12000 W	15000 W	18000 W	24000 W	5500 W	7500 W
Rated Voltage	220-240 V, 50Hz, AC			400 V, 50/60Hz 3Phase, AC				220- 230V,50/60Hz, AC	
Wiring Size	3 x 2.5mm ²	3 x 4mm ²	3 x 6 mm ²	4 x 2.5 mm ²	4 x 2.5 mm ²	4 x 4 mm ²	4 x 6 mm ²	3 x 2.5 mm ²	3 x 4 mm ²
Required Rating of Circuit Breaker	32 amps	40 amps	50 amps	25 amps	25 amps	32 amps	40 amps	32 amps	40 amps
Rated Pressure	0.02 – 0.6 Mpa								
Safety Class	IP25								
Temp.Setting range	30°C - 55°C			30°C - 60°C				30°C-50°C	30°C-55°C
Rate of flow	1.5 - 10 L/min			1.8 - 12 L/min				1.5 - 10 L/min	
Temperature Raise (Δt) @	5 L/min	16°C	19°C	26°C	-	-	-	16°C	21°C
	7 L/min	11°C	14°C	18°C	25°C	31°C	37°C	11°C	18°C
	10 L/min	8°C	10°C	13°C	17°C	21°C	26°C	8°C	11°C
	12 L/min	-	-	-	14°C	18°C	21°C	29°C	-
Dimensions (mm)	A	310	338	385				170	380
	B	210	211	260				220	225
	C	70	72	90				55	80

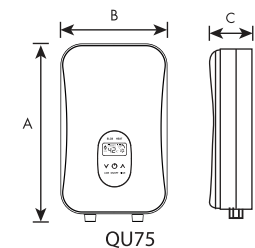
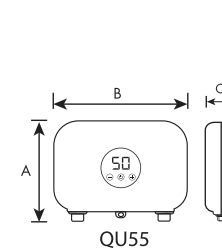
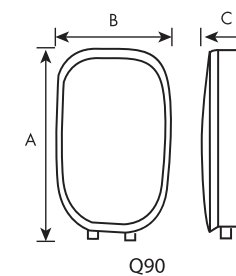
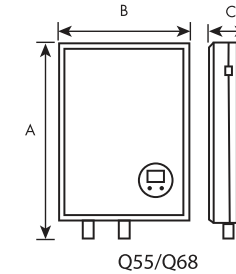
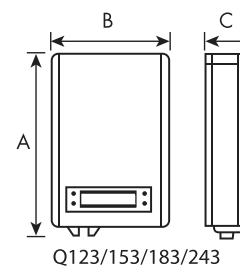

GUARANTEE

2 Years on Product



Brizo



Sunshine Gold



Silver Charm



French Violet

Brizo Plus / Brizo

Brizo Plus / Brizo offers an effective, space-efficient, and user-friendly answer to hot water requirements. Utilizing precise temperature management and continuous supply, Brizo Plus stands as a fitting selection for modern homes, apartments, and businesses. With Brizo Plus, users can experience instant hot water, concurrently curbing energy wastage and elevating convenience



Porcelain Enamel Glass Lined Tank:

Manufactured in a modern, automated plant using European Technology. Protects the tank from rust and corrosion.

Brizo Plus with LED Indicator

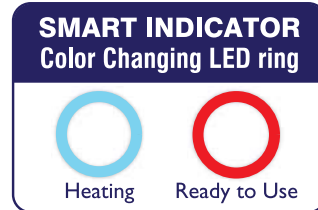

Brizo with Neon Lamps

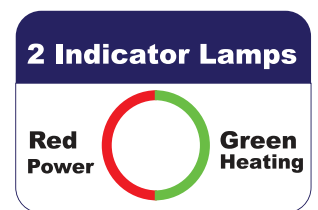

Copper Heating Element



Capsule Polyurethane Foam (PUF) insulation



ABS Plastic Outer Body : Corrosion free. Shock proof.

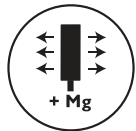

Sacrificial Magnesium Anode for Corrosion protection



Multi-function valve

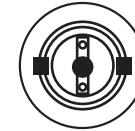

Thermal Cutout



Guarantee on inner tank (3B30 Models Only)



8 bar pressure: Suitable for pressure pumps and multi-storey buildings.

Model	Wattage	Capacity in Litres	Temp rise at 3L/Min	Dimensions (in mm)		
				Vertical	A	B
3B30	3000	3	15°C	380	220	226
3B45	4500	3	21°C	380	220	226
3BB30	3000	3	15°C	380	220	226
3BB45	4500	3	21°C	380	220	226

Rated Pressure: 8bar (8kg/cm² : max, 80m water head)

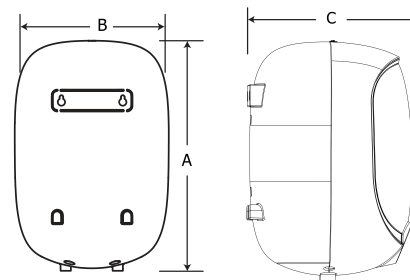

GUARANTEE	Brizo Plus		Brizo
	Inner Tank	7 Years	5 Years
Heating Element	3 Years	2 Years	
Product	2 Years	2 Years	

*Specifications subject to change without prior notice.



NEW



Jiffy



White



Ivory

Jiffy

Introducing Jiffy, the best water heater. This stylish instant beauty is most suited for the modern and stylish interiors.

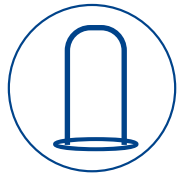

Hi-grade SS 304L Inner Tank : Stainless Steel for corrosion free performance.

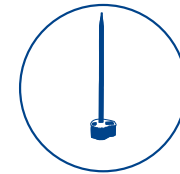

Stem Thermostat : Senses water temperature quickly and precisely protect against over heating safety function.



Copper Heating Element

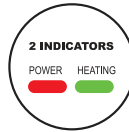

Indicator Lamps : Two LED's - Green for Heating & Red for Power



Plastic Outer Body : Corrosion free. Shock proof.



Stem Thermal Cutout



Pressure Release Valve : Prevents build up of excessive pressure inside tank.



6 Bar Pressure: High Working pressure that is double that of ordinary Instant water heaters.

Product Specifications

Model	Capacity in Ltrs	Wattage	Temp rise at 3L/Min	Dimensions in mm		
				A	B	C
J45	1	4500	21 °C	280	189	158
3J30	3	3000	17 °C	320	207	176
3J45	3	4500	24 °C	320	207	176

Rated Pressure : 6 bars (6 kg/cm²; max, 60 m water head)

Specifications subject to change without prior notice

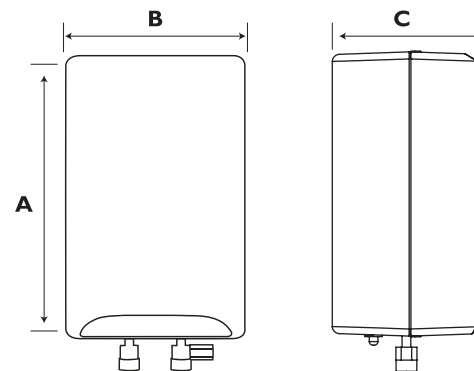

GUARANTEE

Inner Tank 5 Years	Heating Element 2 Years	Product 2 Years
-----------------------	----------------------------	--------------------



Lava



Ivory



White

Lava

Need hot water at the flick of a switch!!! Get hot water in an instant!!! The indicator lamps (green for heating and red for power) makes it convenient for use.



100% pure copper tank: For long life and corrosion free performance. Has single, high quality weld joints.

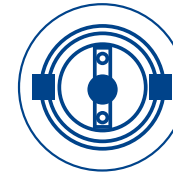

Thermal Cutout : Backup safety device cuts off power at 100°C. Prevents overheating.



Copper Heating Element



Capsule Polyurethane Foam (PUF) insulation

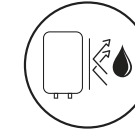

ABS Outer Body : Corrosion free. Shock proof.

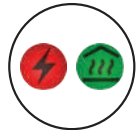

Red - Power , Green - Heating



Multi-function valve



6 Bar Pressure: High Working pressure that is double that of ordinary instant water heaters.

Model	Wattage	Capacity in Litres	Temp to Raise at 3L/Min	Dimensions (in mm)			
				A	B	C	D
			Lava Instant				
3L30	3000	3	17°C	353	248	188	87
3L45	4500	3	24°C	353	248	188	87

3L30/3L45: Rated Pressure: 6bar (6kg/cm² : max, 60m water head)

*Specifications subject to change without prior notice.

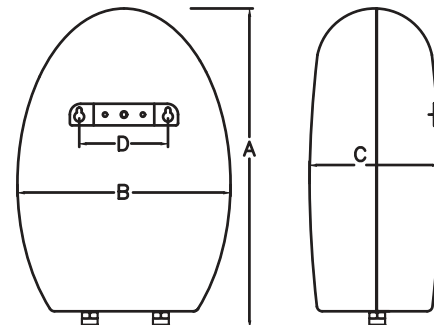

GUARANTEE

Inner Tank 10 Years	Heating Element 2 Years	Product 2 Years
------------------------	----------------------------	--------------------



More than
70%
Energy
Savings*

Heat Pump



Commercial Heat Pump



All in One Heat Pump



Heat Pump Swimming Pool

Domestic Heat Pump

Venus introduces Heat Pump Water Heaters in India. Using renewable energy heat sources from the ambient air to heat water, these heaters can provide hot water round-the-clock and throughout the year in an energy-efficient and affordable way. Venus Heat Pump Water Heaters are the right solution for domestic hot water applications. Get non-stop hot water anywhere in the house while saving as much as 75-80% on your heating costs. A solitary heat pump installed anywhere in the house can supply hot water to all the bathrooms and kitchens.

PRODUCT SPECIFICATIONS

Description			VDHX3i	VDHX5i	VDHX8i	
Rated Heating capacity		kW	3.5	5.0	7.5	
		BTU/h	11940	17060	25590	
Rated Hot Water Output	Inlet Water Temp.15°C	L/h	75	110	160	
	Inlet Water Temp.20°C		85	125	185	
	Inlet Water Temp.25°C		100	145	215	
	Inlet Water Temp.30°C		120	172	260	
Rated Heating power input		kW	0.83	1.19	1.79	
Operating Current		A	3.8	5.4	8.2	
Power supply		V/PH/Hz	220~240V / 1PH / 50~60Hz			
COP		W/W	4.2			
Rated output water temperature		°C	55			
Max outlet water temp		°C	60			
Compressor type			Rotary × 1			
Water side heat exchanger		Type	Tube - Tube			
Dimension (A x B x C)		mm	930 x 360 x 550	930 x 360 x 550	930 x 360 x 550	
Noise level		dB(A)	≤43dB(A)	≤48dB(A)	≤52dB(A)	
Fan discharging		Type	Horizontal			
Ambient temperature		°C	(-)7~43			
Refrigerant		Type	R410A			
Water connection			3/4"			
Cabinet			Powder Coated			
Suggested water tank		Liter	100-300	500	1000	
		Inner Tank	Porcelain Enamel Glass Lined Tank		Epoxy coated / SS	
Net weight		kg	40	45	54	
Gross weight		kg	45	50	60	
Guarantee (Heat Pump)			2 years			
Guarantee (Tank)			5 years		1 year	
Tank dimension			D	E	D	E
		100 Lts	510	1000	-	-
		200 Lts	560	1385	-	-
		300 Lts	650	1520	-	-
		500 Lts	-	-	710	2000
			-	-	1050	2000

Testing condition - Heating: Ambient temp. (DB/WB): 20°C/15°C, water temp. (input/output): 15°C/55°C.
* Conditions apply.

FEATURES



Compressor

Intelligent Electronic controller

Low operating cost - more savings



High Energy Efficiency - COP of 4.2



Split system for flexible installation



Water circulation technology



5 YEARS GUARANTEE ON INNER TANK

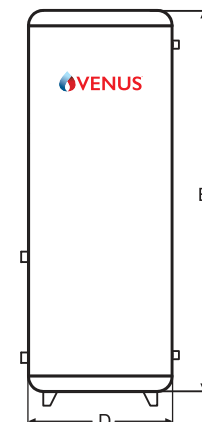
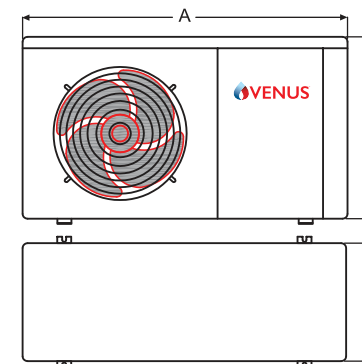

Environmental Friendly Initiatives

Venus Water heaters and innovation goes hand in hand. To add the feather in the crown venus has taken certain initiatives which are environment friendly. A Major move to move away from Thermocol packaging has been in process for quite a few years and the alternate solutions have been innovative on that front. The use of molded pulp buffers in domestic and export water heaters and Ceiling Fans, corrugated buffer (made of kraft paper) replacing instapack buffer, Column airbags (which is bio-degradable and at the same time recyclable) for Instant Water heaters and 6 Ltr Storage Models Our Water heaters have CFC/HCFC Free Insulation that has low global warming potential and Zero Ozone depletion potential. This ensures no damage to the ozone layer and minimum impact on global warming.



Low Global Warming

Environmental friendly PUF insulation material which are highly efficient and have impressively low GWP (Global warming potential) compared to traditional insulation materials thereby actively contributing to reduced greenhouse gas emissions & mitigating climate change



Ozone Friendly Insulation

Using polyol and isocyanate in the production of polyurethane foam (PUF). Our PUF has zero ozone depletion potential (ODP), which ensures it does not harm the ozone layer



9001 & 14001
ISO 9001 & 14001
Certification from BVC





New Generation Packaging

In our efforts to contribute positively to the environment, we have completely revamped our packaging solutions. We've transitioned away from conventional materials such as Thermocol (EPS) and have instead adopted a new range of eco-friendly alternatives. Our innovative packaging choices now include Moulded Pulp Buffer, InstaPack Buffer, Corrugated Buffer, and Column Airbag.

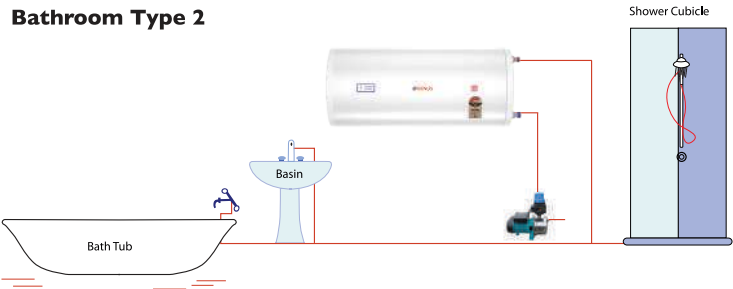
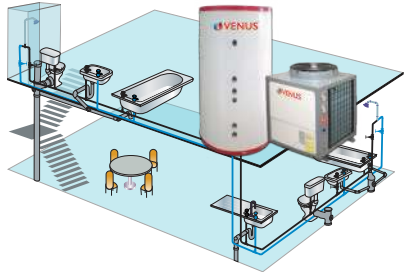

Model Selection Guide

Usage / Application	Climate	
	Moderate	Extreme
Kitchen 	Minimum instant Maximum 10 L	Minimum 15 L Maximum 35 L
Bathroom Type 1 	Minimum instant Maximum 25 L	Minimum 15 L Maximum 50 L
Bathroom Type 2 	Minimum 50 L Maximum 70 L	Minimum 70 L Maximum 100 L
Bathroom Type 3 	Minimum 100 L Maximum 150 L	Minimum 100 L Maximum 150 L

Volume of mixed water at 40°C with cold water		
Capacity	15°C	25°C
10 L	20 L	27 L
15 L	30 L	41 L
25 L	50 L	67 L
35 L	70 L	95 L
70 L	140 L	189 L
80 L	160 L	216 L
100 L	200 L	270 L
150 L	300 L	405 L

A Service that's full of warmth

Venus designs its products to meet demanding national and international standards. You can be sure that this drive for quality is matched by the customer satisfaction record that our after sales service strives for. "Service within 24 hours" is the promise of our committed service personnel. With more than 310+ service centers throughout the country, prompt, economical and reliable service will reach you, wherever you are.



For service with warmth
Call Customer Care



Service in
24 hours



Genuine
spare parts



Nationwide
Service

 **08144666999**

 **+91-9884064999**

Note :

1. Assuming usage is by 1-2 persons.
For more number of people, option for the next higher size.



VENUS HOME APPLIANCES (P) LTD.

CENTRAL MARKETING OFFICE: 4/993, Kamaraj Street,
Rajiv Gandhi Salai (OMR), Kottivakkam, Perungudi Post,
Chennai - 600 096.

